

# alula™

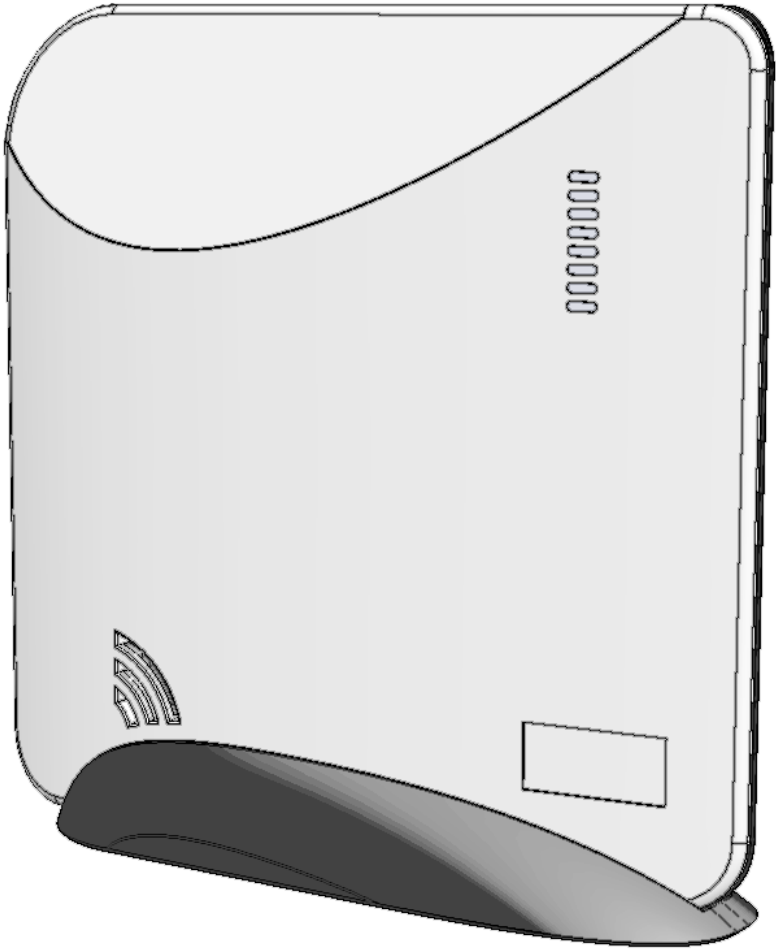

Connect+™ Security and Automation Platform  
RE6100 Series Installation Guide

# Meet Connect+

**Connect+** is a professional wireless security panel designed to deliver home security and automation services. A secured and supervised Ethernet connection comes standard. Optional Cellular and Wi-Fi cards provide primary or backup communication channels. Its long-range encrypted wireless receiver easily provides whole home coverage. Wireless arming stations and mobile devices uncouple Connect+ from the entry wall and allow it to be installed at a location convenient for Internet and power connections.



## **FEATURES**

- Cellular, Wi-Fi, or Ethernet communication channels
- Control from a user's mobile device
- Industry-leading wireless range
- Up to 50 users
- Up to 96 zones
- 2-way voice communication with RE6130
- 5 year warranty

## **ITEMS INCLUDED IN THE BOX**

- The Connect+ panel
- Rechargeable backup battery
- 12-Volt power adapter
- 6-foot Ethernet cable
- Table-top mounting base
- A screw to secure the cover (required for UL installations)
- Installation guide
- Configuration guide
- Platform Guide

## **EXPANSION CARDS FOR INTERNET CONNECTIVITY**

- Wi-Fi™ Card
- LTE Cellular Card (Verizon)

## **OTHER EXPANSION CARDS**

- Z-Wave™ Card
- Existing Security Sensor Translator Card (allows the Connect+ panel to receive signals from existing wireless security sensors)
- Combo Z-Wave & Existing Sensor Translator Card

# System Setup

- 1 Set up a new account** with Alula following the instructions in the platform guide included. You will need the MAC address, which is located on the bottom the panel.

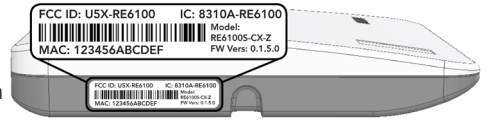

**STOP DO NOT PROCEED UNTIL YOU HAVE FINISHED STEP 1**

- 2 Find a location** for the panel, keeping in mind it needs AC power and at least one network connection.

## Panel Location Guidelines

- Locate centrally on the main floor.
- Avoid mounting below ground level.
- Do not mount near ducts, appliances, or other large metal objects.
- Do not mount directly adjacent to other RF devices.

- 3 Mount the panel** by sliding it downward into the table-top base. Alternatively, the panel can be mounted to a wall using the mounting holes in the back cover. You will need to remove the backup battery to reveal the lower mounting hole.

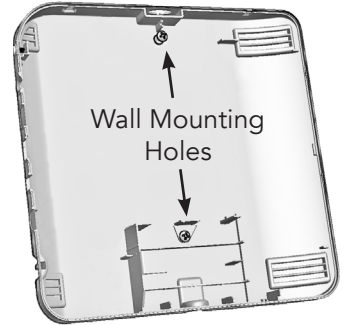

- 4 Connect the panel to the Internet** by wiring its Ethernet port to the home router, or by installing a Cellular or Wi-Fi expansion card (or any combination of the above). The Wi-Fi approach requires enrollment into the home Wi-Fi router.

- If you are using Wi-Fi, then connect the Wi-Fi card to your existing home router by holding the Enroll/WPS button until the panel beeps twice (roughly ten seconds) and then pressing the WPS button on the router.

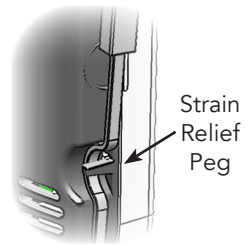

- 5 Power up the panel** by inserting the power supply barrel into the power jack on the side. Route the power cable under the strain relief peg.

## UL Installation Requirements

- Install the cover-securing screws.
- Do not connect the panel to an AC power receptacle controlled by a switch.
- The power supply must be secured to an outlet if installed in the USA.
- The power supply must NOT be secured to an outlet if installed in Canada.

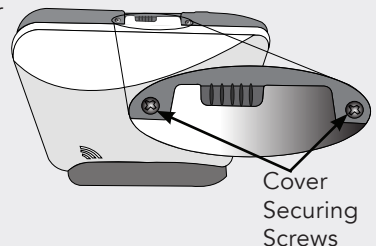

- 6 Enroll sensors and peripherals** by first pressing the Enroll/WPS button on the side of the panel until it beeps once (roughly 3 seconds) and then sending an enrollment signal from the sensor or peripheral. Alternatively, a device can be enrolled by scanning its bar code using the Connect+ Installer app or by entering its 8-character serial number on the Alula dealer portal.

#### Enrollment Tips

- Enrollment signals are typically triggered by removing the battery tab or tampering the device. See the specific device manual for more information.
- The *Connect+ Installer App* can be used to enroll and configure sensors.
- The Alula dealer portal provides a way to enter and exit wireless enrollment mode.
- Wireless enrollment mode will end 5 minutes after the last sensor is enrolled.
- Enrolling a Keypad or other 2.4GHz peripheral will automatically end wireless enrollment mode.
- Tapping the Enroll/WPS button will end wireless enrollment mode.

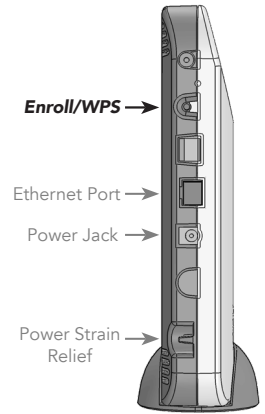

- 7 Install your sensors & peripherals** in desired locations around the house. Refer to the specific device manual for more information regarding installation and use.

#### Typical Burglary Protection Installation

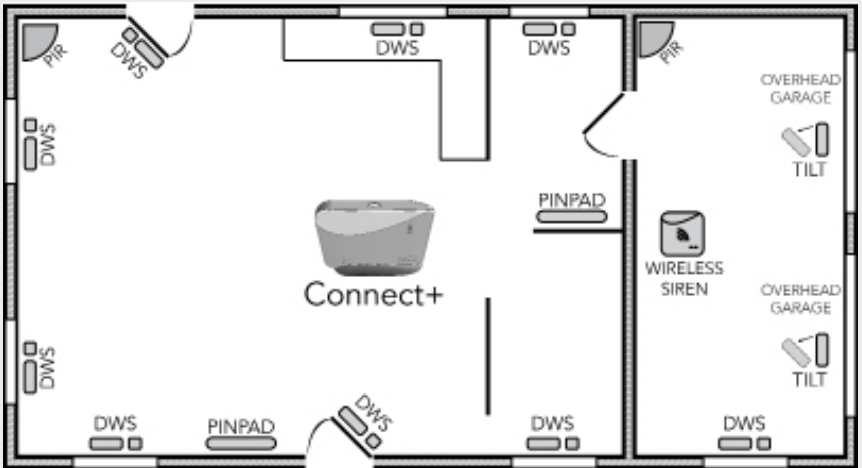

- 8 Configure the panel, sensors, and peripherals** using the *Connect+ Installer app* or the Alula dealer portal. Configuration options are described in the configuration guide.

- 9 Finally, test the system** after finishing installation, enrollment, and configuration. Verify proper operation of all installed sensors and peripherals using the *Connect+ Installer app* or the Alula dealer portal. All sensors and peripherals should score at least one bar on the RF signal strength indicator. See *Pro Tips - RF Signal Strength*.

## Pro-Tips

**Install an expansion card** by first disconnecting AC power and the battery. Cellular cards must use slot 1 and square cards must use slot 3. Always refer to the specific card manual for a full list of installation requirements. Next, **carefully align** the nylon retention posts and 8-pin connector while pushing the card firmly until all the posts are fully seated. Finally, reconnect the battery, AC power, and verify proper operation using the LED indicators on the expansion card.

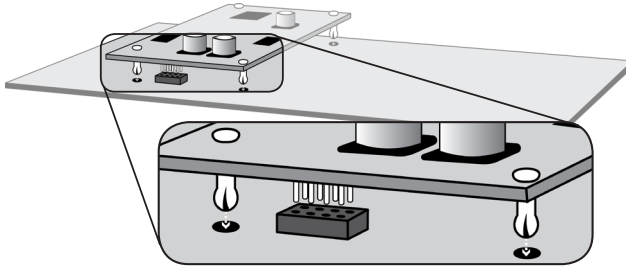
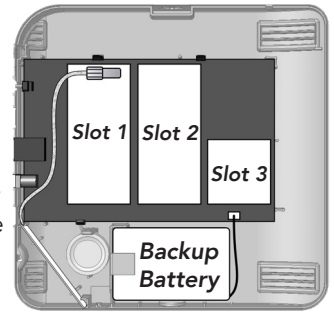

### Cellular Antenna Installation

- Route the antenna wire near the Ethernet jack as shown above.
- Install the antenna with the feed wire on the top side as shown to the right.

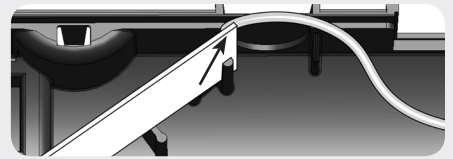

**RF Signal Strength** is an averaged signal-to-noise indication. Even in the absence of sensor transmissions, the panel experiences ambient RF energy (i.e. noise). The RF signal strength indication represents a sensor's signal relative to ambient noise. If multiple sensors score low signal strength, this could be due to one or more of the following:

1. **High ambient noise** - Ensure the panel is not mounted adjacent to other electronics.
2. **Panel isn't centrally located, or is mounted below ground** - Move the panel to a central location in the home that is above ground level.
3. **Panel is located near ducts, appliances, or other large metal objects** - Relocate the panel away from these types of objects.

### Sensor Signal Strength Tips

- The signal strength scale is from 0 to 100 (0 to 5 bars).
- There is **nothing wrong** with a sensor that has at least one bar (e.g. a signal strength of at least 20).
- Signal strength readings are averaged. If you move the panel or a sensor, it takes some time for the signal strength readings to update. Tripping a sensor several times will help update a sensor's signal strength faster.
- Before mounting a sensor permanently, expose a slight portion of its mounting tape and apply it (**very lightly**) to the desired location. If it performs well, mount it permanently. If it performs poorly, try rotating it by 90 degrees.
- **Do not test a mounting location by tripping a sensor in your hand.** Holding a sensor changes how it radiates RF energy. Sometimes these "hand effects" help, and sometimes they hurt.

**Wireless performance** of door window sensors is optimized when mounted vertically near the top corner of the door.

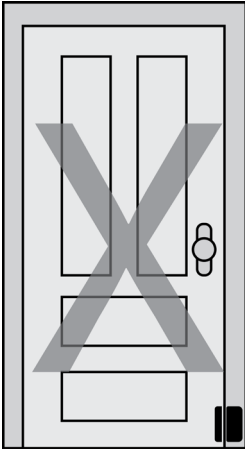

**WRONG**

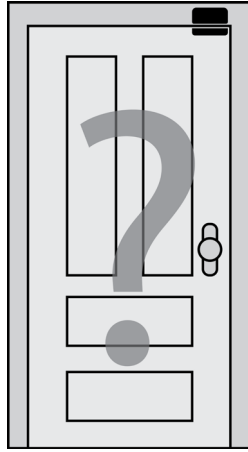

**OK**

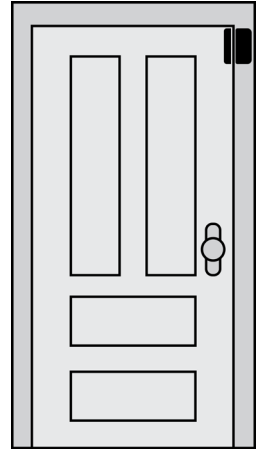

**BEST**

**Routers, modems, and other electronic devices** emit RF noise. For best results, avoid mounting the panel directly beside other electronic devices.

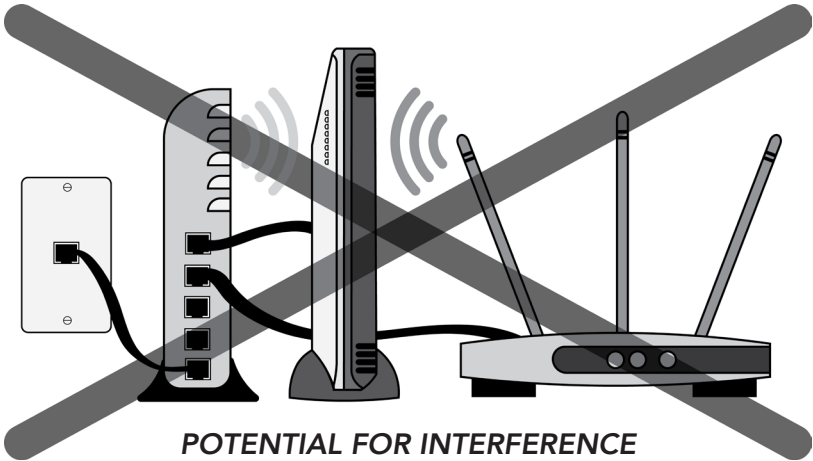

- Put some space between the panel and the home router. A 6-foot cable is included for this purpose.

**Trouble beeps can be suppressed** so they only occur during a specific window of time each day.

- Use the Connect+ Installer app or the Alula dealer portal to configure the trouble beep suppression period.
- Trouble beeps can be temporarily silenced for 24 hours using a Keypad or Keypad.

**The Connect+ Installer App** can be used to enroll sensors by scanning the barcode.

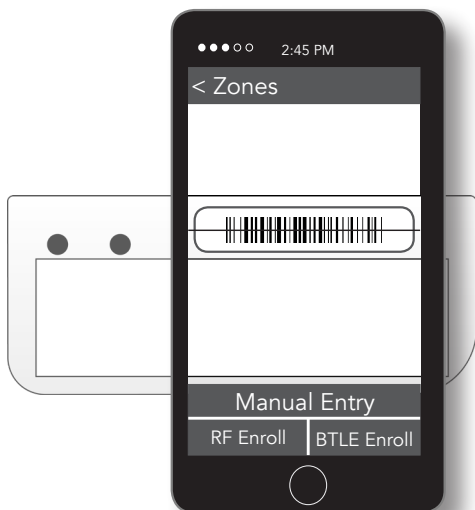

**Smoke Alarms** should be installed in accordance with Chapter 2 of "ANSI/NFPA 72: National Fire Alarm and Signaling Code" (National Fire Protection Association, Batterymarch Park, Quincy, MA 02169) when installed in the USA. Smoke alarms installed in Canada should be installed in accordance with "Standard for the Installation of Residential Fire Warning Systems, CAN/ULC-S540".

### Smoke Alarm Placement

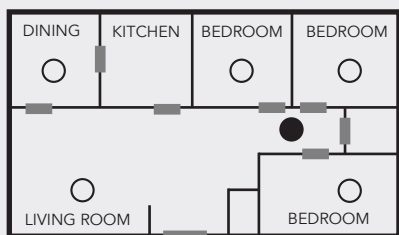

(Single Sleeping Area)

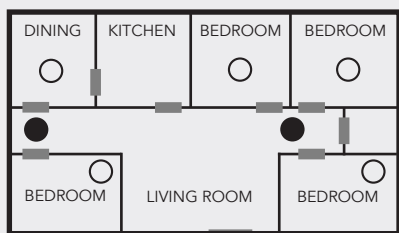

(Multiple Sleeping Areas)

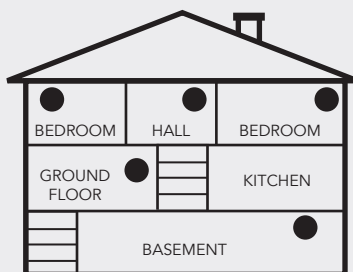
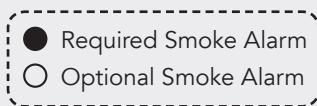

(Multi-Floor Home)

NOTE: Regulations pertaining to smoke alarm installations vary. Contact your local fire department for more information.

**Should the battery need replacing**, remove the cover, disconnect the old battery, and connect a new battery. The battery connector is polarized and can be inserted only one way into the panel receptacle.

# Emergency Planning

**Emergencies happen**, so have a plan.

## **Emergency Planning Tips**

- Periodically discuss and rehearse emergency plans.
- Understand how to use your security system.
- Know the normal states of doors and windows: open, closed, or locked.
- Escape fast! (Do not stop to pack.)
- Use a different escape route if closed doors feel hot to the touch.
- Smoke is toxic. Stay low and breathe strategically when escaping a burning building.
- Designate a nearby landmark as a safe family re-grouping location.
- Emphasize that no one should return to the premises if there is a fire.
- Call 911 as soon as possible but do it in a safe location.
- Do not enter the premises if you arrive and hear sirens. Call for emergency assistance from a safe location.

## Using the Connect+ Panel

**System Status Indication** is provided via eight LEDs on the front of the panel. These LEDs may all be forced OFF to conserve battery power during an AC power failure.

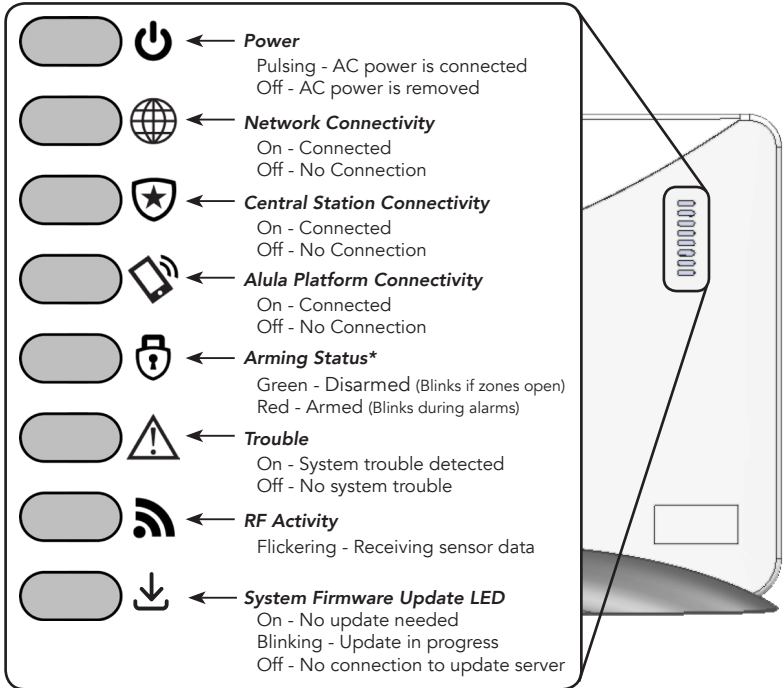



\* This LED will toggle between green and red while wireless enrollment mode is active.



## Using the Keypad (See the Keypad manual for detailed operation)

**Disarm the system** by entering a valid user code on the number pad.

**Arm Away** by pressing ARM AWAY  until the Keypad clicks.

**Arm Stay** by pressing ARM STAY  until the Keypad clicks.

**Trigger a panic alarm** by pressing ARM STAY  & ARM AWAY  together until the display indicates a panic alarm.

**View real-time system status** using the Keypad's display.

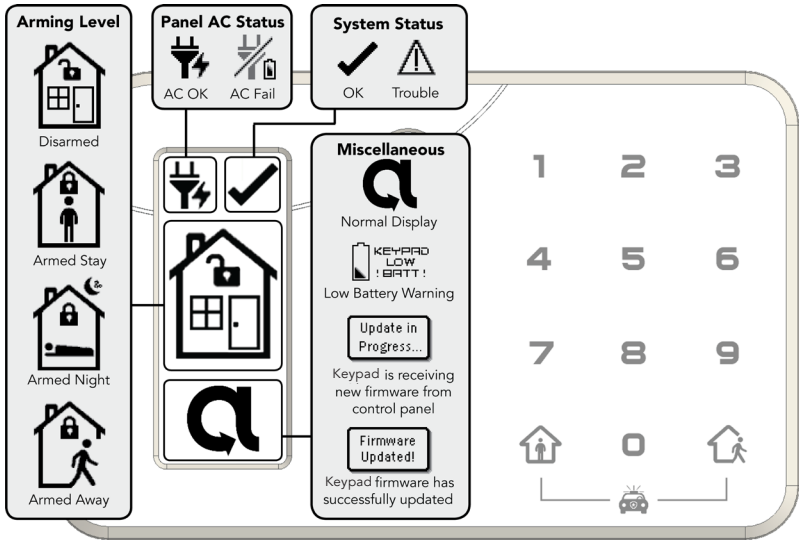
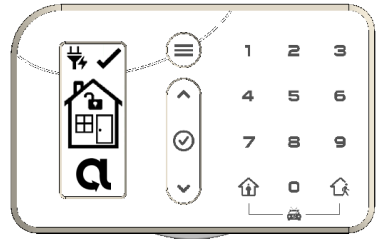

## Using PINPad (See PINPad™ manual for detailed operation)

**Disarm the system** by entering a valid user code on the number pad.

**Arm Away** by pressing the "AWAY" button until the PINPad LED flashes red.

**Arm Stay** by pressing the "STAY" button until the PINPad LED flashes red.

**Trigger a panic alarm** by pressing the "STAY" & "AWAY" buttons together until the PINPad LED flashes red.

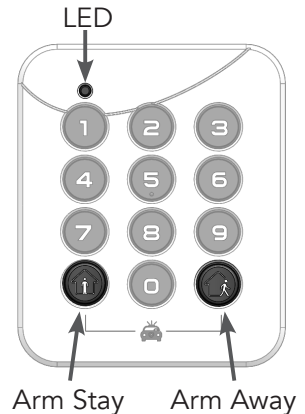

# Connectivity Troubleshooting

<b>Symptom</b>	<b>Troubleshooting Steps</b>
<b>Network Connectivity LED Off</b>	<p><b>Ethernet Connections</b></p> <ol style="list-style-type: none"><li>1. Ensure the Ethernet cable is fully inserted in both the panel and router/modem.</li></ol> <p><b>Wi-Fi Connections</b></p> <ol style="list-style-type: none"><li>1. Ensure the Wi-Fi card is properly installed, and the Power LED on the card is pulsing.</li><li>2. Ensure the panel has been configured with the proper Wi-Fi credentials and the Wi-Fi LED on the expansion card is on solid. If the LED is blinking either the network is not in range, or the Wi-Fi credentials are incorrect (refer to <i>System Setup - Step 4</i>).</li></ol> <p><b>Cellular Connections</b></p> <ol style="list-style-type: none"><li>1. Ensure the Cellular card is properly installed, and the Power LED on the card is pulsing.</li><li>2. Inspect the LED on the expansion card.<ul style="list-style-type: none"><li>• A solid LED indicates the panel is connected to the network.</li><li>• A flashing LED indicates the panel has found a tower, and is attempting to connect to the network. Wait until the LED is solid. If the LED has been double flashing for more than ten minutes, try power cycling the panel.</li></ul></li></ol>
<b>Central Station Connectivity LED Off</b>	<ol style="list-style-type: none"><li>1. Ensure the Network Connectivity LED is on. If it is off, see the network connectivity troubleshooting section above.</li><li>2. Ensure port TCP 9999 is open in the router/modem settings.</li><li>3. Ensure the panel is registered to an account with Alula and the account is active.</li><li>4. Ensure the panel has been configured with the proper central station reporting information: Account Number, Central Station Receiver Host and Port, Central Station Receiver ID and Line ID.</li></ol>
<b>Alula Platform Connectivity LED Off</b>	<ol style="list-style-type: none"><li>1. Ensure the Network Connectivity LED is on. If it is off, see the network connectivity troubleshooting section above.</li><li>2. Ensure port UDP 1234 is open in the router/modem settings.</li><li>3. Ensure the panel is registered to an account with Alula and the account is active.</li></ol>
<b>System Firmware Update LED Off</b>	<ol style="list-style-type: none"><li>1. Ensure port UDP 1235 is open in the router/modem settings. The panel and peripherals will not be able to receive firmware updates if this port isn't available or is already in use.</li></ol>

## System Maintenance

**System testing** should be performed after installation is completed and whenever a problem occurs.

Smoke and CO alarms should be tested after installed and weekly by pressing the test button on the alarm. The panel will indicate it has properly received a test signal by sounding a temporal three sound for a Smoke alarm or a temporal four sound for a CO alarm.

Critical functions and communication links of the system are automatically monitored and exercised to detect trouble conditions.

# Regulatory

## UL SYSTEM REQUIREMENTS

### Control Unit, consisting of:

- Base Panel: RE6100 series
- Backup Battery: RE029 (6V, 2.5Ah, NiMH)
- Power Supply: RE012-6 (In: 100-240VAC; Out: 12VDC, 1A)
- PINPad (RE652) or Keypad (RE656), connected wirelessly
- Ethernet connection native to base panel or Cellular module (RE928RxS, RE928RxV, or RE927RxA)

### Compatible ETL listed signal initiating devices:

- RE614 Smoke Alarm
- RE615 CO Alarm
- RE653 Outdoor Motion Sensor
- RE659 360 Motion Sensor
- RE661 Indoor Motion Sensor
- RE601 Door/Window Sensor
- RE622 NanoMax Door/Window Sensor
- RE610P Motion Detector

### Optional devices, not ETL listed:

- Any of a wide array of Connect+ compatible sensors

### UL1023 Household Burglar Alarm System:

- Control Unit
- At least one burglary signal initiating device
- Entry delay: 45 seconds or less
- Exit delay: 60 seconds or less
- Sensor supervisory: 24 hours or less
- Panel status volume: on
- Panel siren: on
- Auto force arm: on
- Siren timeout: 4 minutes or more

### ORR-C1023-1974 Canadian Household Burglar Alarm System:

- Control Unit and installation as described for UL1023
- Power supply: RE012-6, Do NOT secure with a receptacle securing screw. Ne pas se connecter Connect+ à une prise contrôlée par un interrupteur.
- Siren timeout: 6 minutes or more

### UL985 Household Fire Warning System (Not applicable with RE6130):

- Control Unit
- At least one smoke signal-initiating device enrolled into "Fire" zone profile.
- Smoke supervision: on
- Panel siren: on
- Siren timeout: 4 minutes or more
- Panel status volume: on

### ULC-5545-M89 Canadian Household Fire Warning System (Not applicable with RE6130):

- Control Unit and installation as described for UL985
- Power supply: RE012-6, Do NOT secure with a receptacle securing screw. Ne pas se connecter Connect+ à une prise contrôlée par un interrupteur.
- Siren timeout: 6 minutes or more

### Central Station Communicator Requirement is at least one of:

- UL1610 Central Station Burglar Alarm System: Ethernet connection native to base panel  
-OR-
- UL1635 Digital Alarm Communicator System: Cellular module RE928RSS, RE928RSV, or RE927RSA
- RF supervision: 4 hours
- Communication interface supervision: on
- Entry delay plus reporting delay must not exceed 60 seconds.
- Reporting delay is 30 seconds.

### Network Equipment:

- Use a UL 60950-1 listed broadband router/modem for the 10/100 Ethernet port or Wi-Fi connection

### UL 1610 Commercial Burglar Alarm System:

- Commercial: on
- The product shall be installed in accordance with National Electrical Code, ANSI/NFPA 70, the standard for Installation and Classification of Burglar and Holdup Alarm Systems, UL 681, the Standard for Central-Station Alarm Services, UL 827, CSA C22.1, Canadian Electrical Code, Part I, Safety and Standard for Electrical Installations, CAN/ULC S302, Standard for the Installation, Inspection and Testing of Intrusion Alarm Systems, and CAN/ULC S301, Installation, Inspection and Testing of Intrusion Alarm Systems, and CAN/ULC S301, Standard for Signal Receiving Centre Intrusion Alarm Systems and Operations.
- Ethernet Port must be connected directly to a router without any Ethernet switches.
- Siren Test: Siren should be tested once a week. Trip alarm to sound the siren. Disarm system to silence siren. Contact Central Station if alarms will be reported.
- Intended use includes: Commercial Central Station, Encrypted Line Security, Single and Dual Signal Line Transmission
- Communication interface options need to have supervision enabled depending on panel setup. Ethernet, Slot 1, Slot 2.

## CE SYSTEM REQUIREMENTS

### Access Levels:

- Access Level 1: Person with no access to the security system features.
- Access Level 2: Regular users with access to all features on the security system with a code.
- Access Level 3: Master and Alarm company users that can do everything a level 2 user can do and also change system settings (e.g. add, modify, or delete users).
- Access Level 4: Manufacturer of equipment access. Typically used for system updates.

### User Codes:

- Four or more invalid code attempts will disable the interface and trigger a tamper condition.
- There are 10,000 unique 4-digit PIN codes.
- There are 16,777,215 unique identification codes for logical keys (Keyfobs).

### Priority of Indicators:

- Fire alarm
- CO alarm
- Panic alarm
- Burglary alarm
- Tamper alarm
- Auxiliary alarm
- Freeze alarm
- Heat alarm
- Water alarm
- Tamper indication
- Fault indication

### Ancillary Control Devices:

- Up to 8 PINPads (RE652)
- Up to 8 Keypads (RE656) and/or mobile devices.
- PINPads and Keypads can issue panic alarms

# ANSI-SIA CP-01 REQUIREMENTS

## Required Equipment:

- RE6100 Connect+ Panel
- RE656 Keypad

**Note:** Combined entry delay and abort window should not exceed 1 minute.

**Note:** Programming at installation may be subordinate to other UL requirements for the intended application.

## Nonprogrammable SIA Options

Nonprogrammable Options	Setting
Silent Exit	Annunciators Enabled
Progress Annunciation	Annunciators Enabled
Cancel Report Annunciation	Enabled
Recent Closing	Enabled (2 Minute Window)
Exit Error	Enabled
Restoration of Power	Panel will ignore sensor trips for the first sixty seconds after power-up
Cancel Alarm	Enabled
Remote Arming	Annunciators Enabled

## SIA Setting Requirements

Programmable Options	Default	Recommended Setting	Range
Entry Delay	30 Seconds	30 Seconds	30-240 Seconds
Exit Delay	60 Seconds	60 Seconds	45-240 Seconds
Abort Time	30 Seconds	15-45 Seconds	1-45 Seconds
Auto Stay Arming	On	On	On/Off
Exit Delay Restart	On	On	On/Off
Swinger Threshold	Two Trips	Two Trips	1-6 Trips
Duress	Disabled	Disabled	Disabled, valid duress code
Cross Zoning	Disabled	Enabled for sensors that may cause false alarms	On/Off
Fire Alarm Verification	Disabled	Enabled unless sensor can self verify	On/Off
Alarm Abort Annunciation	On	On	On/Off
Alarm Cancel Annunciation	On	On	On/Off

# User Information - Definitions

**Report Delay:** Consult with your installer to determine if your system is configured with a communicator delay. A communicator delay will prevent a report to the central station if the control panel is disarmed within \_\_\_\_ seconds (default is 30 seconds) after an intrusion alarm is triggered. Note that fire-type alarms and Carbon Monoxide alarms are normally reported without a delay.

**Exit Delay:** The period of time allowed, after Arming a security system, to exit the entry/exit door without tripping an alarm. Note: Enabling silent exit doubles the exit delay time

**Entry Delay:** The door used to enter the premise will start an entry delay when tripped. You will hear entry delay beeps when you trip the sensor: this will allow you time to disarm the system. Entering a user code will disarm the system.

**Entry Delay Progress:** Three beeps every four seconds and three beeps every two seconds during the last ten seconds of entry delay.

**Exit Delay Progress:** Two beeps every two seconds and two beeps every second during last ten seconds of exit delay time.

**System Acknowledgment:** Sounders will sound one beep to confirm disarm, two beeps to confirm stay arming and four beeps to confirm away arming.

**Exit Delay Restart:** The feature will recognize when you arm the system, leave your house and then quickly re-enter. If this happens, the system will restart your exit delay to give you the full exit delay again.

**Auto Stay Arming:** Determines whether the system automatically arms down to Stay if you arm the system to Away without exiting the system entry/exit door. This feature will not be enabled when arming from a keyfob.

**Arming Level - Disarm:** In this level, only 24-hour sensors are active.

**Arming Level - Stay:** Perimeter sensors are active. Interior sensors are not active.

**Arming Level - Away:** Perimeter and interior sensors are active.

**Panic Alarm:** To trigger panic alarm from Keypad, press and hold stay and away buttons at the same time.

**Alarm Abort:** If the panel beeps three times after disarming an alarm, then the alarm is aborted.

**Alarm Cancel Report:** If an alarm has previously been transmitted, a cancel signal will be transmitted when the alarm system is disarmed. The panel will sound two beeps three seconds after disarming when sending a cancel message.

**Alarm Memory:** After canceling an alarm, press status on Keypad to view alarm memory.

**Duress Code:** The user uses a unique code, which disarms the system and transmits a "Duress" alarm to the monitoring center.

**Cross Zoning:** Refers to two different sensors that must be tripped within two minutes of each other to report an alarm to the central station. When motion is detected by the first sensor, it starts a two minute timer. If the other sensors trip within two minutes, an alarm report will be sent to the central station.

**Swinger Shutdown:** This setting determines how many times the sensor will go into alarm during a single arming period. Once the sensor is in swinger mode it will not be active again until the alarm is canceled.

**Note: Swinger shutdown does not affect Fire and Carbon Monoxide sensors.**

**Fire Alarm Verification:** The panel immediately reports to the central station when a smoke alarm goes into alarm. With this option on, if a single smoke alarm goes into alarm, the panel will not report for 60 seconds unless another smoke alarm goes into alarm. If the first smoke alarm is cleared of an alarm within the first 60 seconds, no report will be sent to the central station unless it or a second smoke alarm goes into alarm within 5 minutes.

# User Information - Testing the System

**Before testing alarms**, contact your central station and tell them you are testing the system.

Central station phone number \_\_\_\_\_

System account number \_\_\_\_\_

**Test door/window sensors** by first closing all doors and windows that have sensors. Verify the display on the keypad or mobile app indicates the system is in the ready state. Trip each sensor by opening the door or window and verify it shows open at the keypad or on the mobile app.

**Test smoke alarms** by pressing the test button until smoke alarm sounds. Check mobile app activity to verify fire walk test signal was reported. (The sirens will play one cycle of the temporal 3 siren pattern when a smoke test is pressed).

**Test CO alarms** by pressing the test button until CO alarm sounds. Check mobile app activity to verify CO test signal was reported. (The sirens will play one cycle of the temporal 4 siren cadence when a CO test is pressed.)

**Test glassbreak sensors** using a glass break sound tester to trip sensor.

**Testing Panic Alarms:** Panic alarms will be reported to the central station and will cause the panel siren to sound. Ensure your central station knows you are testing the system. Press the panic button and verify the system goes into alarm. To test panic alarms on the RE656 Keypad and RE652 PINPad, press and hold the stay and away arming buttons to trigger a panic alarm.

**Test panel communication** by verifying the alarms you tripped were reported to and received by the central station.

**When finished, remember to tell the central station you are done testing the system.**

***THIS PAGE IS INTENTIONALLY LEFT BLANK***

# Specifications

## PHYSICAL

Housing Body Dimensions	8.9 x 8.9 x 1.5 inches (22.6 x 22.6 x 3.8 cm)
Housing Base Dimensions	8.2 x 1.3 x 2.7 inches (20.8 x 3.3 x 6.7 cm)
Weight with Battery	26.8 ounces (760 grams)
Mounting Fastener	#6 or #8 screws (not provided)

## ENVIRONMENTAL

Operating Temperature	32 to 120 °F (0 to 49 °C)
Storage Temperature	-4 to 86 °F (-20 to 30 °C)
Maximum Humidity	85% non-condensing relative humidity

## PANEL SPECIFICATIONS

Radio Frequencies	433.92MHz, 2.4GHz
Power Supply Part Number	RE012-6 (US), RE012-7 (AUS), RE012-8 (CE)
Input	100-240VAC, 50/60 Hz, 0.5A
Output	12VDC, 1A
Battery Part Number	RE029
Backup	24 hours minimum (4 hours minimum for RE6130)
Specifications	6VDC, 2.5Ah, NiMH
Battery Charger	25mA (Trickle), 95mA (Fast)
Current Draw (RE6100, RE6110, RE6120)	150mA (Normal), 300mA (Alarm)
Current Draw (RE6130P-XW-X)	250mA (Normal), 400mA (Alarm)
Current Draw (RE6130P-LX-X)	150mA (Normal), 400mA (Alarm)
Tamper Indications	Cover opening and Wall removal
Sensors	Up to 96 Connect+ Compatible Wireless Security Zones
Interface Devices	Up to 8 PINPads (RE652) Up to 8 Keypads (RE656) and/or mobile devices, up to 4 Touchpads
Maximum Number of Users	50

## CERTIFICATIONS

RE6100	UL1023, UL985, UL1635, UL1610, ORD-C1023-1974, ULC S304, ULC-S545-M89, ETL, FCC, IC
RE6110	EN 60950-1, EN 300 220, EN 301 489, RCM
RE6120	EN50131-3, EN 60950-1, EN 300 220, EN 301 489, CE
RE6130P-XW-X	UL1023, UL1635, ORD-C1023-1974, ETL, FCC, IC
RE6130P-LX-X	UL1023, UL985, UL1635, ORD-C1023-1974, ULC-S545-M89, ETL, FCC, IC

*Specifications subject to change without notice.*

## WARRANTY

Alula will replace products that are defective in their first five (5) years.

## IC NOTICE

This device complies with Industry Canada license-exempt RSS standard(s). Operation is subject to the following two conditions:

- (1) This device may not cause interference, and
- (2) This device must accept any interference, including interference that may cause undesired operation of the device.

Le présent appareil est conforme aux cnr d'Industrie Canada applicables aux appareils radio exempts de licence.

L'exploitation est autorisée aux deux conditions suivantes:

- (1) L'appareil ne doit pas produire de brouillage, et
- (2) L'utilisateur de l'appareil doit accepter tout brouillage radioélectrique subi, même si le brouillage est susceptible d'en compromettre le fonctionnement.

IC: 8310A-RE6100

## TRADEMARKS

Alula and Connect+ are trademarks owned by Alula Holdings, LLC.

## FCC NOTICE

This device complies with Part 15 of the FCC rules. Operation is subject to the following two conditions:

- (1) This device may not cause harmful interference.
- (2) This device must accept any interference that may be received, including interference that may cause undesired operation.

Changes or modifications not expressly approved by Alula could void the user's authority to operate this equipment.

FCC ID: U5X-RE6100

## CE DECLARATION OF CONFORMITY

Hereby, Alula declares that this RE6120 is in compliance with the essential requirements and other relevant provisions of directive 1999/5/EC.

*(This declaration can be translated to other languages via a myriad of translation tools found on the Internet.)*